

## Project2 / Bai\_Tap [CPU 1212C DC/DC/DC] / Program blocks

### Bai\_Tap [OB1]

#### Bai\_Tap Properties

##### General

Name	Bai_Tap	Number	1	Type	OB
Language	LAD	Numbering	automatic		

##### Information

Title	"Main Program Sweep (Cycle)"	Author		Comment	
Family		Version	0.1	User-defined ID	

#### Bai\_Tap

Name	Data type	Default value
▼ Input		
Initial_Call	Bool	
Remanence	Bool	
Temp		
Constant		

#### Network 1: Y1

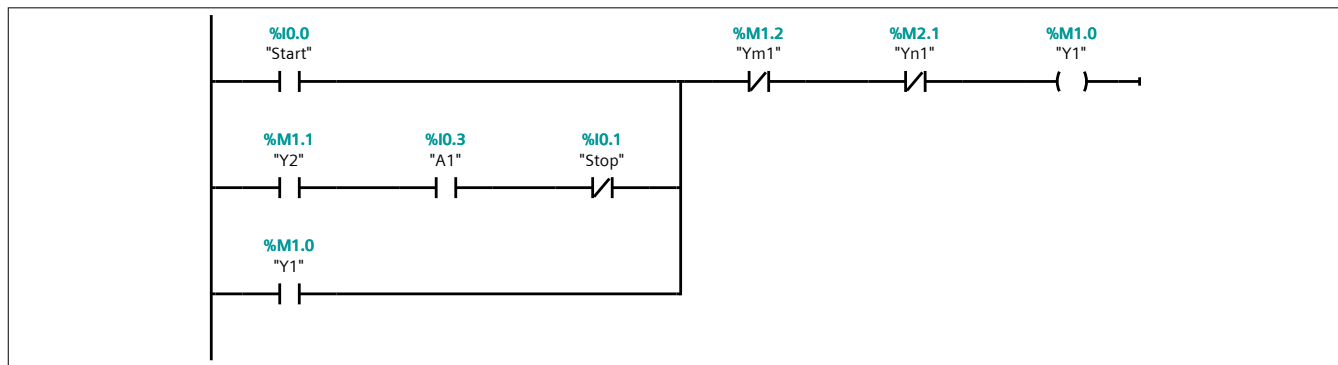

#### Network 2: Ym1

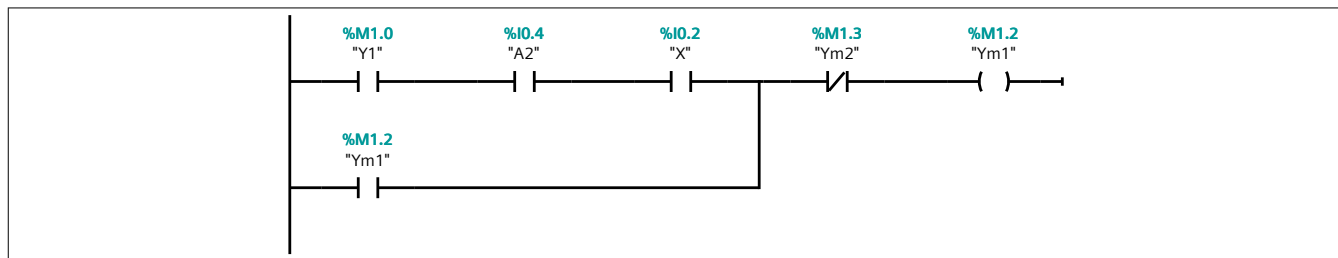

#### Network 3: Ym2

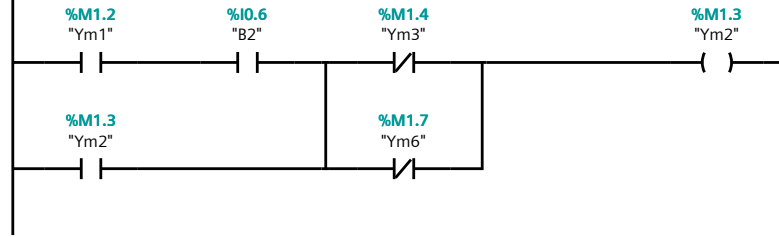

Network 4: Ym3

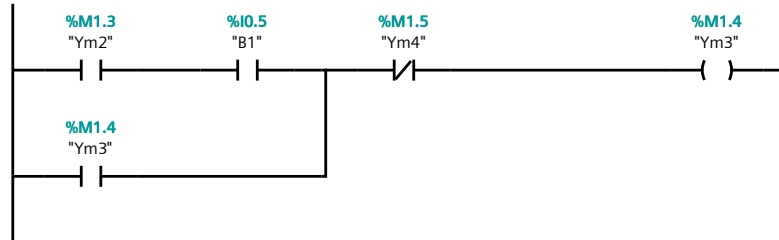

Network 5: Ym4

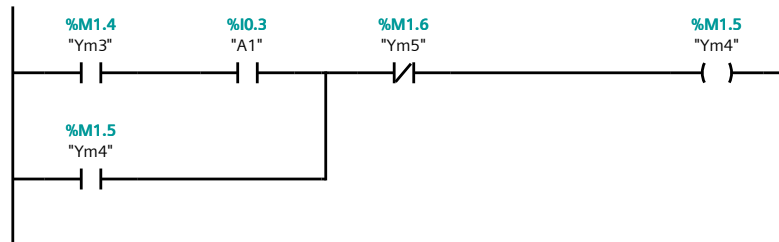

Network 6: Ym5

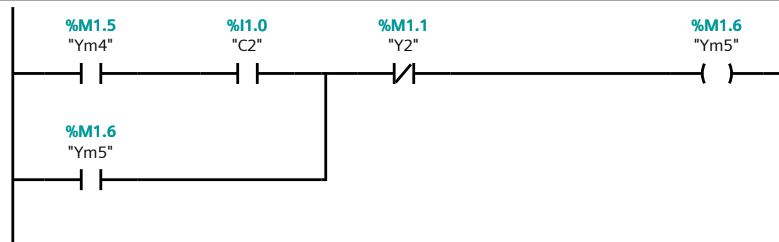

Network 7: Ym6

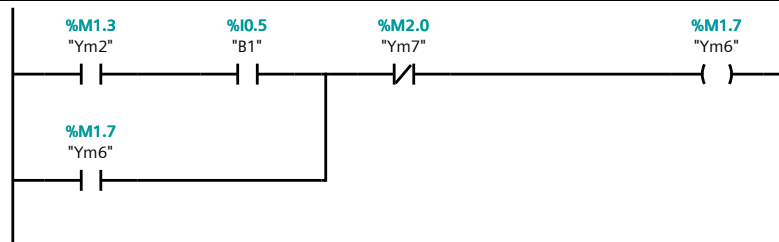

### Network 8: Ym7

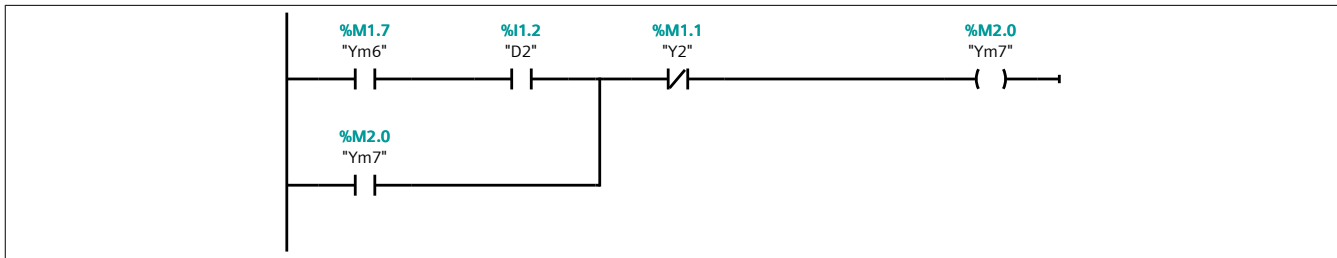

### Network 9: Yn1

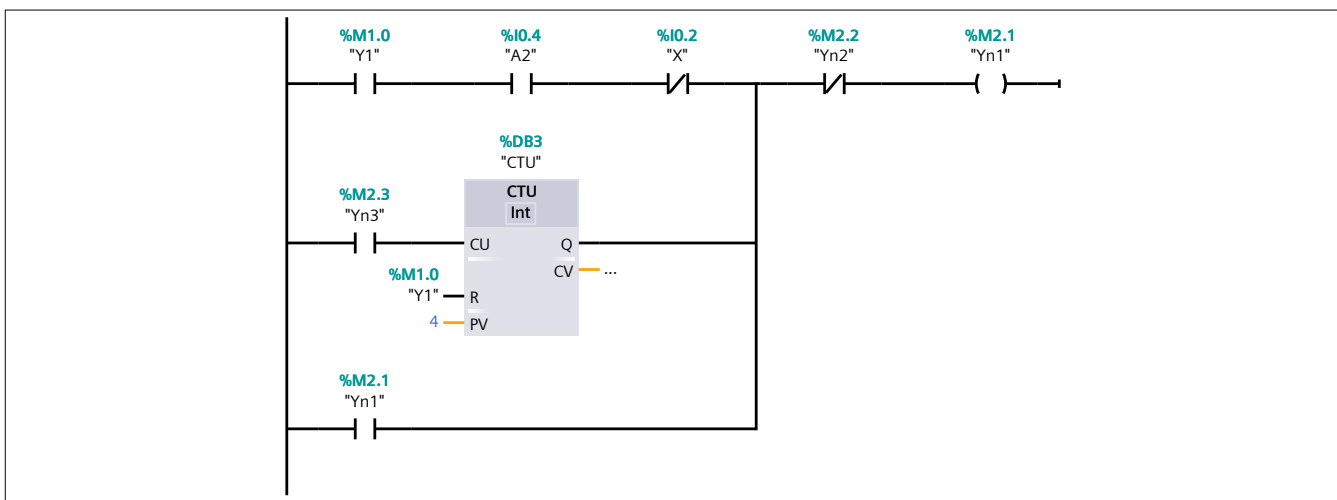

### Network 10: Yn2

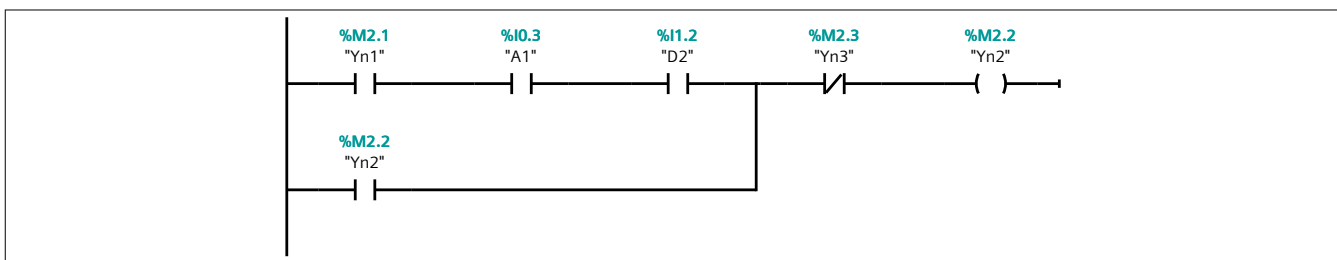

### Network 11: Yn3

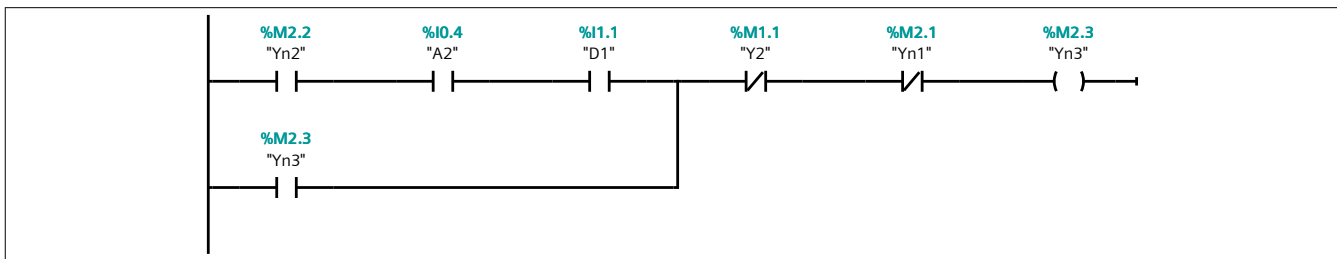

### Network 12: Y2

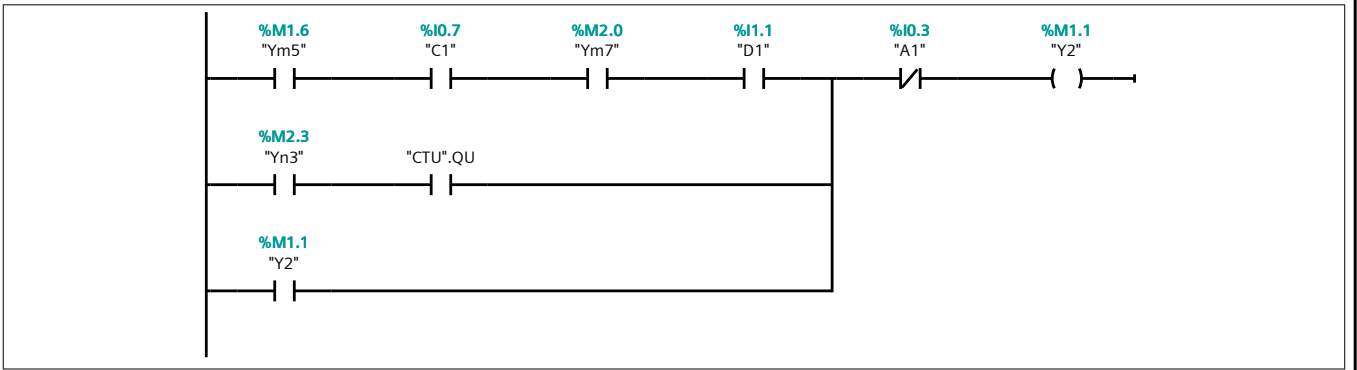

Network 13: A

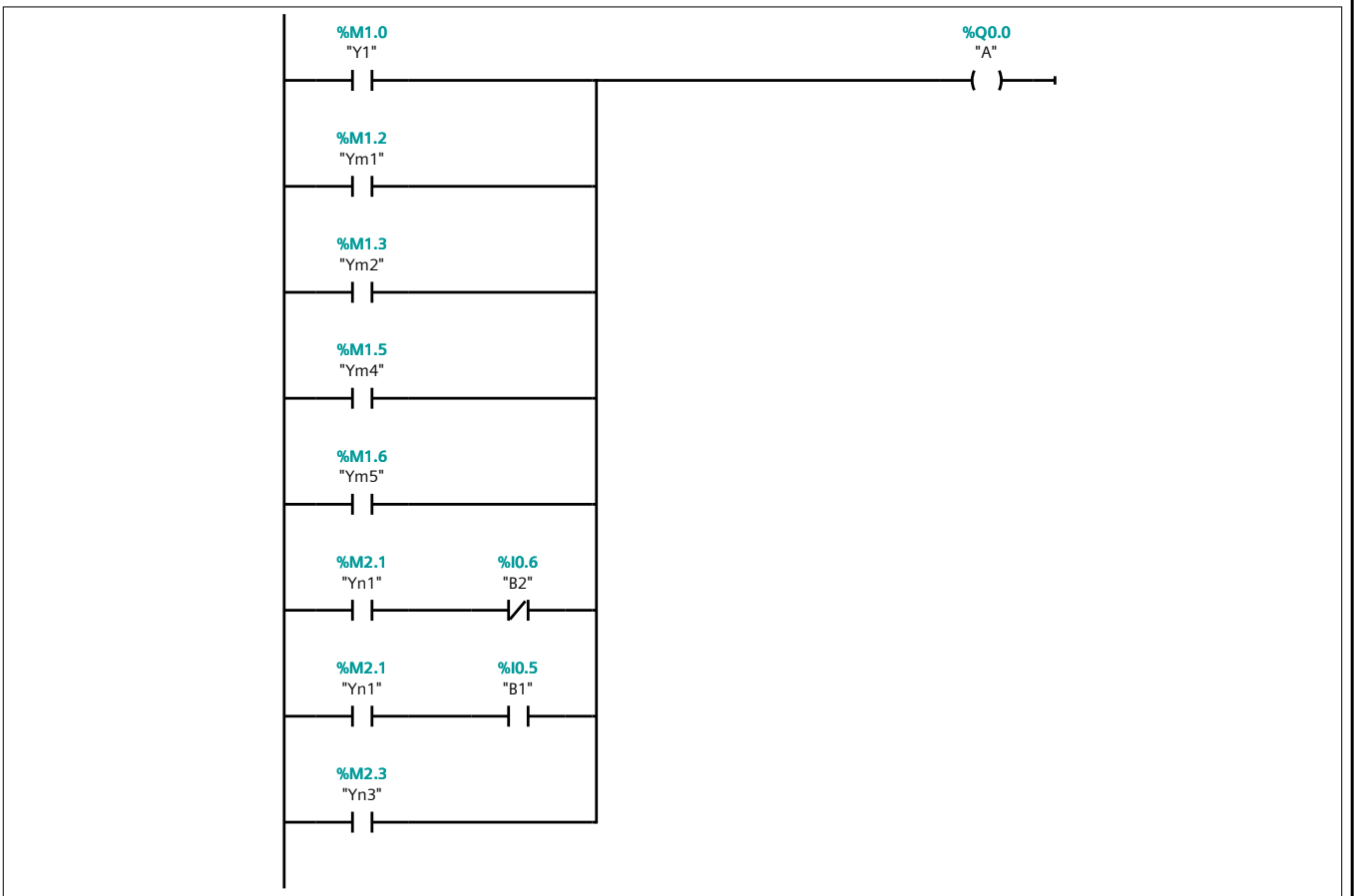

Network 14: B

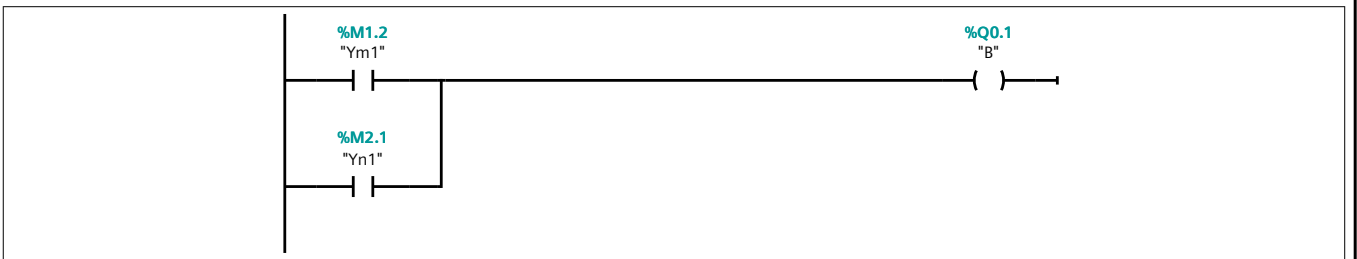

Network 15: C

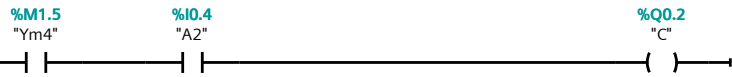

**Network 16: D**

